

TECHNICAL INFORMATION

on the

SOLOVOX

Model L

(Tone Cabinet No. 92000 and above)

FOR those owners who are interested in knowing exactly how the Solovox works, and for the use of any capable radio technician who may be called upon to repair the Solovox, should it ever need such service. We suggest that this booklet be kept inside the piano bench.

HAMMOND INSTRUMENT COMPANY

4200 West Diversey Avenue

Chicago 39, Illinois

MODEL L SOLOVOX

This booklet describes the Model L Solovox, which was introduced in 1948. This model differs from the Model K primarily in three respects. (1) An electronic vibrato replaces the former mechanical type, giving quieter and more reliable operation. (2) An improved mute circuit produces both string and clarinet-like tones of constant volume over the entire range of the keyboard. This constancy of volume is appreciated by the player as it reduces the number of knee-swell movements. (3) A completely new tuning system enables the musician to play more rapidly because it instantly selects the highest note played. The new tuning circuit also eliminates switching of frequency dividers as the musician plays over the keyboard, resulting in a perfect tone quality match for all keys.

Model J and K technical information is available from Solovox dealers or direct from the factory.

HOW THE SOLOVOX WORKS

All notes of the Solovox are controlled by a double triode vacuum tube master oscillator operating at the audio frequencies of the three highest octaves of the instrument (523 to 3951 cycles per second). Thus the master oscillator operates over the full keyboard range of three octaves. Each time a key is depressed, a contact under it tunes the oscillator to the pitch associated with the corresponding key in this three octave range.

The output of the oscillator is fed into a series of three cascaded frequency dividers, each of which divides its input frequency by two and thus produces a note an octave lower than its input frequency. The three dividers thereby provide pitches of one, two, and three octaves below the pitch of the oscillator. In this way, when the oscillator is tuned to some given note, each divider produces a note in exact octave relation to the oscillator, thus forming a series of four notes having exact octave relationships. The particular frequency divider or dividers selected for sounding through the amplifier and speaker will depend upon which of the BASS, TENOR, CONTRALTO, AND SOPRANO controls are used.

A control contact under each key serves to transmit the signal to the speaker with a controlled rate of attack so as not to be musically abrupt. Tuned electrical circuits associated with the amplifier make it possible to alter the quality of tone over a wide range.

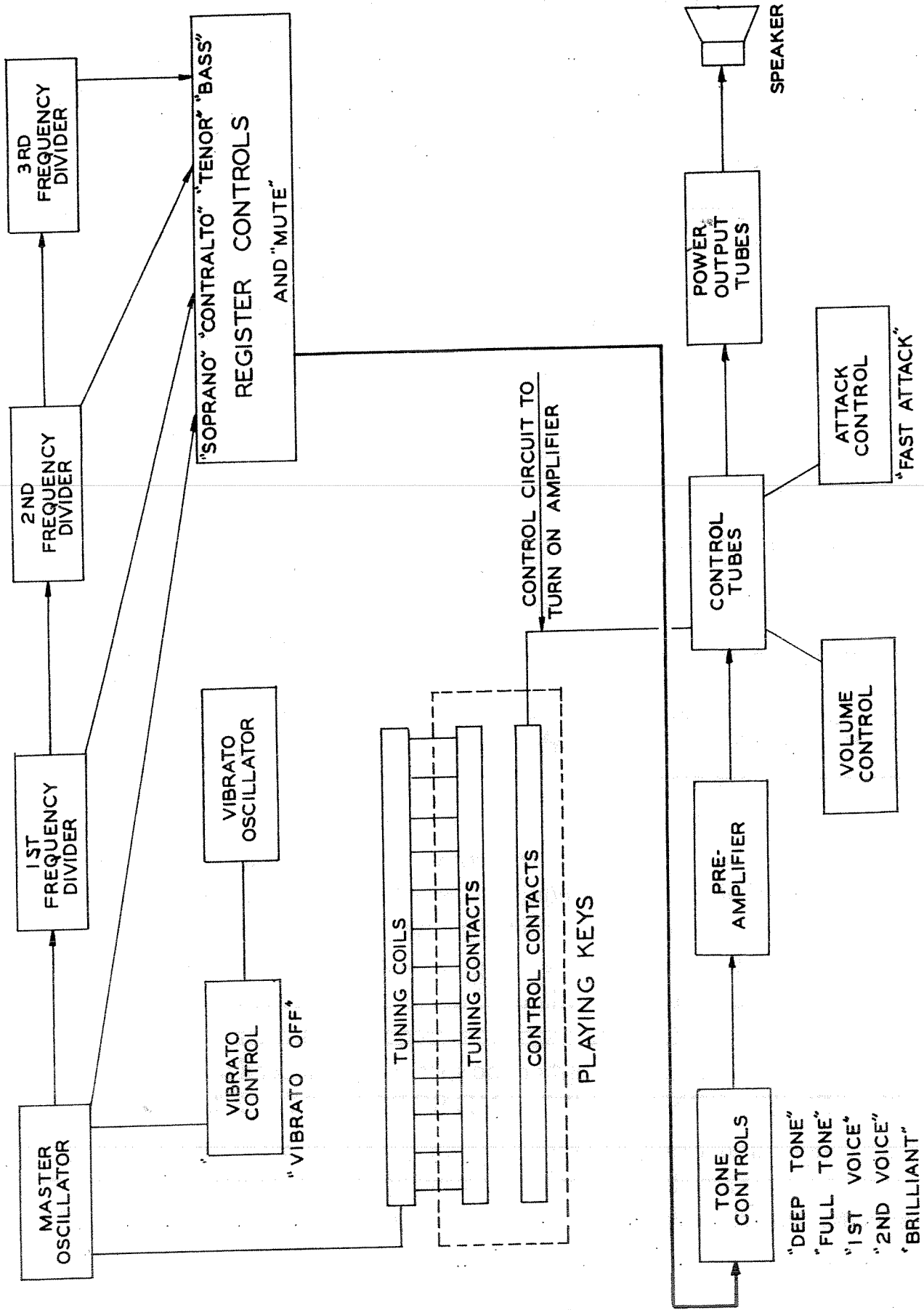

BLOCK DIAGRAM - SOLOVOX MODEL L

FIGURE 4

WIRING DIAGRAMS

In studying the operation of the Solovox, refer first to the block diagram (Figure 4), and second to the more detailed schematic circuit (Figure 1A) which is on the separate inserted sheet. Note that the arrangement of elements is exactly the same in these two drawings.

The Oscillator

The 36 coils which tune the audio frequency oscillator to the highest three octaves, shown in Figure 1A, are located in the tuner box at the rear of the Solovox keyboard. When the lowest "C" key is played (this key has no tuning contact), all 36 coils are connected in series to form the tuning inductance of the oscillator. When any other key is depressed, the tuning contact under it shorts out some of these coils (making less total inductance) and thus tunes the oscillator up to the pitch associated with that key. If two keys are depressed at the same time the higher pitched of the two will sound.

Frequency Dividers

Each divider includes three triodes. One acts as a driver and pulse rectifier, supplying sharp and narrow negative pulses to actuate a symmetrical feed-back tripping circuit comprising two triodes in one 6SN7 tube. Either one (but only one) of these two triodes can be conducting at a time, for by drawing plate current it holds the other in a cut off condition.

Suppose, for example, that the first triode is conducting and the second is cut off. Now a negative input pulse impressed on the grids of both triodes will not affect the second one, which is already cut off, but will cut off the first. This produces a positive pulse at the plate of the first triode, which is applied to the grid of the second triode through its feed-back connection. The second triode then suddenly conducts current, producing a negative pulse at its plate. This negative pulse, applied to the first triode grid through its feed-back connection, insures that the first triode remains cut off. The situation is now exactly reversed, with the first triode cut off and the second conducting.

The next input pulse will act on the second triode, cutting it off again and making the first conductive; and thus two input cycles are required to produce one output cycle. Each frequency divider circuit therefore divides its input fre-

quency in half, producing an output signal one octave lower than the preceding divider. The triode plates of each divider stage furnish an output signal of rectangular wave shape as well as the signal to drive the next divider stage.

This divider circuit is capable of operating satisfactorily with wide variations in voltage, input frequency, and values of components, and therefore is remarkably stable and requires no adjustments.

Register Controls

From the preceding, we see that whenever any one of the three G# keys, for instance, is depressed, the frequency dividers, together with the oscillator, provide a series of four G# notes in exact octave relations. The particular divider whose output is to sound through the speaker is selected by the register controls ("BASS-TENOR-CONTRALTO-SOPRANO"). Thus the register controls shift the pitch range of the Solovox keyboard to four different positions. If two or more of these controls are depressed simultaneously, a composite tone will be heard, consisting of the outputs of several dividers simultaneously sounding in their octave relations.

The Mute

The electrical waves produced by the oscillator and frequency dividers are of rectangular shape, consisting of odd harmonics and representing the clarinet or woodwind family of tone qualities. This type of tone is heard with the mute control "on".

To produce the string quality tones heard with the mute control "off", even harmonics must be added. These are obtained by adding rectangular waves from higher frequency dividers, in reduced amplitude. This effect is possible because the fundamental frequency of the tenor range, for instance, is the same as the second harmonic of the bass range, the fundamental of the contralto range is the same as the bass fourth harmonic, and so on.

In the case of the soprano range, since no higher octaves are available, the string tone is obtained directly from an "oscillator rectifier" tube which produces a combination of odd and even harmonics from the oscillator output.

Note: Models J and K Solovox have different mute circuits. (See Page 3).

"Deep Tone," "Full Tone," "First Voice," "Second Voice," and "Brilliant" Controls.

Just ahead of the preamplifier is a series of tone controlling circuits arranged to alter the frequency characteristic of the amplifier in a manner similar to radio tone controls. For instance, with "DEEP TONE" the signal develops across a condenser which emphasizes the low frequencies; with "FULL TONE" the signal develops across a resistor with a small condenser in shunt, which leaves the frequency characteristic essentially flat except for the very high frequencies; "FIRST VOICE" puts a resonance in the 400 cycle zone; "SECOND VOICE" puts a resonance near 800 cycles; and with "BRILLIANT" the signal develops across an inductance, emphasizing the higher frequencies. These tone control circuits are connected in series, and may be used singly or in groups. At least one of the five tone controls and at least one of the register controls must be in "on" position before any signal can be heard from the loud speaker.

Control Tubes V9 and V10

As mentioned before, the control contacts under the playing keys serve to remove the cutoff bias from control tubes V9 and V10. This is explained by considering that the cathodes of tubes V9 and V10 are connected to the midpoint of the voltage divider shown below the control tubes in Figure 1A. When no playing key is pressed, this voltage is about 150 volts positive with respect to ground, and, therefore, these tubes are cut off. When any playing key control contact is closed, a resistance totaling 2700 ohms is put in parallel with the lower leg of the voltage divider and this causes the cathode voltage to drop to about 50 volts. This removes the cutoff bias from control tubes V9 and V10, which are of the remote cutoff type. The 6 mfd. condenser serves to make the tonal attack and decay rate smooth. A condenser connected between the keying circuit and the center tap of transformer T2 produces a slow rate of attack but can be disconnected if desired by operating the "fast attack" switch.

Volume Control

The volume of the Solovox is controlled by a knee-operated rheostat. This rheostat is actually a switch connected to seven fixed resistors and is, therefore, not subject to wear as is the usual type of volume control. This rheostat forms part of a voltage divider circuit which varies the grid bias to the remote cutoff control tubes V9 and V10 and, therefore, changes the gain of these tubes to pro-

duce a corresponding change of volume from the speaker. The grid potential varies from approximately 25 volts at the maximum volume position (depending on setting of maximum volume control), to approximately ground potential at the minimum position (depending on setting of minimum volume control).

The Vibrato

The vibrato effect is produced by means of a 6-cycles-per-second vacuum tube phase shift oscillator which drives a vacuum tube switching circuit. As the switching tube is turned on and off by the vibrato oscillator, it shunts a small condenser intermittently across the master oscillator tuning circuit and causes the master oscillator frequency to vary, producing a vibrato effect.

Tuning

The Solovox, as a whole, is tuned by adjusting the capacity of the tuning condenser and thereby changing the frequency of the master oscillator.

Two tuning knobs accomplish this by shunting additional capacities across the main tuning condenser.

Power Output Stage

V11 and V12 are power output pentodes connected in the usual push-pull manner to drive the permanent magnet type loud speaker.

Power Supply

The power supply of the Solovox uses a single rectifier tube, V13. Note that control tubes V9 and V10 have a separate heater winding on power transformer T1. This prevents an appreciable difference in potential from arising between the heaters and cathodes of control tubes V9 and V10.

TUNING AND SIMPLE ADJUSTMENTS WHICH ANY OWNER CAN MAKE

Tuning

The Solovox ordinarily remains in tune indefinitely. However, because of the variation in pitch of the piano or other instruments with which the Solovox is to be played, two tuning adjustment knobs have been provided. These are located

under the keyboard to the left of the volume control. Tuning the Solovox is a very simple matter, as all of the tones are simultaneously tuned by making this single adjustment.

To tune the Solovox, first adjust the knob farthest to the left (rough tuning adjustment) for approximate tuning, with the other knob (fine tuning adjustment) in its center position. Then adjust the fine tuning knob until the tuning is accurate. For greatest accuracy, only the "CONTRALTO", "VIBRATO OFF", and "DEEP TONE" control tablets should be "in" and the middle octave F# key of the Solovox tuned to the corresponding piano note. (A control tablet is "in" when the top of the tablet is pushed in.)

Adjustment of Maximum and Minimum Volume Controls

The maximum volume control knob is located under the keyboard to the right of the volume control. It regulates the maximum loudness when the knee-operated lever is all the way to the right.

The minimum volume control is located a little to the left of the maximum volume control and is provided with a screwdriver slot for adjusting. It is used to regulate the minimum loudness when the knee-operated lever is all the way to the left.

When readjusting both controls, always set the minimum volume control first, as it has some effect on the maximum volume as well. To do this, set the tablets to some useful setting such as "CONTRALTO" and "DEEP TONE". With the knee-operated volume control released, so that it points directly out, hold down a key and turn the slotted minimum volume control until the note is as soft as is useful. (When once set this control will probably not need to be changed. If you ever move it, be sure to check the maximum volume afterwards.)

To adjust the maximum volume control knob, move the knee-operated volume control as far as it will go to the right, holding down a key, and turn the knob to the right until the volume becomes as loud as is useful. Do not turn the knob to the right any further as to do so will only mean that the knee-operated volume control will become unnecessarily sensitive, which is particularly undesirable for the novice and beginner.

PRACTICAL SERVICE SUGGESTIONS

The materials and electrical parts in the Hammond Solovox are of the finest

quality available. Aside from occasional replacement of a vacuum tube, no service problems need be expected to arise. A few conditions which might possibly be encountered are listed below with information which will enable a radio service technician to correct them without difficulty.

1. *Cable Connector.* In case the Solovox fails to play correctly, first make sure that the cable connector in the left end of the keyboard under the piano is secure. The face of the plug and its receptacle should be together. If the Solovox does not play properly, this is the most likely cause.

2. *Replacing tubes.* There are thirteen tubes in the Solovox, as shown on the last page. These are all standard radio tubes, and can be tested and replaced, if necessary, by any radio dealer. All tubes can be reached from the back of the tone cabinet. Be sure to replace all tubes in the exact sockets from which they came.

The two type 6SK7 control tubes (V9 and V10) should be similar to avoid undesirable thumps when playing. It is therefore recommended that both be replaced at the same time with new tubes of the same make.

3. *Instrument Fails to Play.* Ordinarily in this case all the tubes should be tested. If the tubes are lighted, the cable plug is making proper connection, and the controls are in playing position, the most likely source of trouble is the amplifier circuit. In most respects this is a conventional amplifier circuit, and the voltage measurements given on the circuit diagram will enable a radio service technician to locate the trouble.

A dirty key contact may cause an irregular sputtering or crackling of a single note. In this case, move the bus-bar shifters as described in the following suggestions numbered "6" and "7".

4. *One Register Control Does not Play.* If all keys fail to play on one register control with the mute "on," but play correctly with all other controls, the register control tablet may have a dirty contact. It may be cleared by removing the left section of the control panel (which includes the four register controls) and wiping the contacts carefully.

A broken cable wire or poor plug connection in the output circuit of a single frequency divider may cause the same effect. Note that the "BASS" control is connected to the third frequency divider; the "TENOR" control is connected to the second frequency divider; the "CONTRALTO" control is connected to

the first frequency divider; and the "SOPRANO" control is connected to the oscillator.

In case the frequency divider itself is not operating, all dividers below it will also fail to play. A cathode-ray oscilloscope connected from ground to the plate of any divider tube should show a rectangular wave, while the plate of any divider driver tube should show a very sharp and narrow negative pulse.

5. *One Tone Control Will Not Turn Off.* If one of the tone controls does not turn off when pressed in at the bottom, the tone control tablet probably has a dirty contact. It may be cleared by removing the right section of the control panel and wiping the contacts carefully.

6. *One Key Does Not Sound.* If a certain key fails to play on any of the register controls, it probably has a dirty control contact which can be cleared easily by shifting the control contact bus-bar, whose adjustment is at the right end of the keyboard under the molded bakelite end piece. Figure 3A shows how the bus-bar shifters are arranged. Loosen the clamping screw, shift the bus-bar about 1/32", and tighten the clamping screw carefully.

7. *One Key Plays Lowest "C" Note Instead of its Correct Pitch (with adjacent keys playing correctly).* In this case the key has a dirty tuning contact which can be cleared easily by shifting the tuning contact bus-bar, whose adjustment is at the left end of the keyboard. Adjust as described in the preceding paragraph.

8. *Key Thumps or Clicks.* If a transient effect in the form of an annoying thump appears each time a key is released, the two type 6SK7 control tubes V9 and V10 are probably not matched properly. In this case install two new tubes of the same make. A loud click each time a key is released indicates that the control tube cathode condenser (6 mfd. 200 V.) is probably open or partially open.

9. *Hum.* An excessive 120 cycle hum in the speaker indicates that one of the filter condensers is open or low in capacity.

10. *Tuning of Individual Notes.* The individual note tuning system employed in the Model L Solovox consists of 36 small inductance coils, each of which is adjustable by moving the coil on its iron core. This tuning system is much more stable than the piano because it has practically no aging effect and is very insensitive to ordinary humidity and temperature changes. However, after long use under extremely adverse humidity conditions it is possible that

some notes of the instrument may not be exactly in tune with each other. Before concluding that this is the case, carefully tune the middle F# note as described on page 8. Remember that under these extreme conditions of humidity pianos frequently get out of tune very rapidly (in a matter of hours). If you are sure that the tuning discrepancy does lie in the Solovox notes and not in the piano, the individual notes may be retuned as follows:

- (a) Connect the speaker output of the Solovox to one set of plates of an oscilloscope, and connect the speaker output of a Hammond Organ to the other set of oscilloscope plates. In case a Hammond Organ is not available, you can use a new Solovox accurately tuned to A-440 pitch. When tuning with the organ, use the first white drawbar (fundamental) only and the highest three octaves of organ keys.
- (b) Remove the bakelite front and back covers of the tuner box at the rear of the Solovox keyboard, exposing the numbered tuning coils. The keyboard wiring diagram, Figure 3A shows the location of these coils.
- (c) In order to stop the vibrato completely, connect cable terminal No. 3 to ground. Set the rough tuning and fine tuning controls to their center positions. With "CONTRALTO," "VIBRATO OFF," and "DEEP TONE" tablets pressed in at the top, hold down the highest B keys on the Solovox and organ. Loosen the clamping screw on coil 36 and slide the coil carefully up or down until the Solovox note is tuned to the corresponding organ note as indicated by the oscilloscope wave pattern either standing still or moving very slowly (one cycle in two or more seconds). Tighten the clamping screw.
- (d) Release the B keys and hold down the highest A# keys on the Solovox and organ. Now adjust coil 35 in the same way. Then release the A# keys and hold down the A keys and tune coil 34. Repeat for all the other keys and coils in chromatic order downward. It is important that you start tuning with the highest note and progress down one key at a time because the tuning of the lower keys is dependent upon all of the higher coils.

Note: From the above you can see that tuning the individual notes requires considerable skill as well as a Hammond Organ and oscilloscope. It is not recommended that the owner try to do this himself.

SOLOVOX TUBE SOCKET VOLTAGES

These readings are taken with a 1000 ohms-per-volt meter, having three scales of 50, 250, and 1000 volts. All voltages are taken with a line voltage of 117, and deviations of as much as 20% may be caused by line voltage variations. All controls are off, the volume control is in its softest position, and no key is depressed unless specified. The negative lead of the voltmeter is connected to chassis ground except as noted.

Connect Positive Voltmeter Lead to:	Meter Should Read (Volts)	This Shows Voltage of
" +300"	310	1st filter condenser
" +290"	290	2nd filter condenser
" +280"	280	3rd filter condenser
Ground (neg. to " -2.5")	2.5 to 3.0	Vibrato oscillator bias
Tube V1 (term. #2)	165	Master oscillator plate
Tube V1 (term. #3)	9	Master oscillator cathode
Tube V1 (term. #5)	10	Vibrato switch tube plate
	(Use 250V. scale)	
Tube V2 (term. #2)	185	Vibrato oscillator plate
	(Meter should oscillate slightly)	
Tube V2 (term. #5)	210	Master Oscillator plate
Tube V2 (term. #6)	4	Master Oscillator cathode
Tube V3 (term. #2)	80	Oscillator rectifier plate
Tube V3 (term. #3)	5	Oscillator rectifier cathode
Tubes V3 (term. #5), V5 (term. #2 & 5)	260	Driver Plates
	(Use 1000 V. scale)	
Tube V4, V6, V7, term. #2 & #5)	190	Divider Plates
	(Use 1000 V. scale)	
Tube V7 (term. #6)	40	Driver & Divider Cathodes
Tube V8 (term. #3)	65	Preamplifier plate
Tube V8 (term. #8)	1	Preamplifier cathode
Tubes V9 and V10 (term. #8) ..	280	Control tube plates
Tube V9 (term. #6)	130	Control tube screens
Tube V9 (term. #5)	145	Control tube cathodes
(no key depressed)		(tubes cut off)
Tube V9 (term. #5)	45	Control tube cathodes
(any key depressed)		(tubes operating)
Tubes V11 and V12 (term. #3) .	300	Output tube plates
Tube V11 (term. #4)	290	Output tube screens
Tube V11 (term. #8)	25	Output tube cathodes
Cable terminal #12	0-20	Control tube grids
(Volume control in softest position)		(exact voltage depends on setting of minimum volume control.)
Cable Terminal #12	5-30	Control tube grids
(Volume control in loudest position)		(exact voltage depends on setting of maximum and minimum volume controls.)

AC VOLTAGES

Heater Voltage to all tubes except V13.....	6.3	V. RMS
Rectifier tube V13 filament voltage.....	5	V. RMS
Ground to either plate of rectifier tube.....	300	V. RMS
AC ripple voltage across two 1200 ohm power supply resistors.....	3	V. RMS
AC ripple voltage across 1000 ohm power supply resistor.....	.15	V. RMS

REPAIR PARTS

A great many of the electrical parts are standard radio parts, obtainable at any radio store. Such parts include tubes, resistors, and condensers, both paper and electrolytic. The correct values are given in the diagrams.

The transformers and coils are mostly special. To obtain such parts from us specify the model and serial number of your Solovox tone cabinet and the designation used in Figures 1, 2, or 3. For example: Transformer T1 for Solovox Model L, serial number 80000.

We suggest that if your Solovox should ever need repair you call your nearest Hammond dealer, or ask us where nearest dealer is located. If your Hammond dealer is not conveniently available, this booklet, with the accompanying diagrams, will enable a competent radio service man to locate the trouble.

PATENTS AND TRADEMARKS

"Solovox" is the Trade Mark of the Hammond Instrument Company and is registered in the United States Patent Office.

The Solovox is protected by patents and patents pending in the United States and principal foreign countries, including the following United States Patents.

Des. 123,686	1,956,350	2,142,580	2,253,782
Des. 124,405	2,099,204	2,203,569	2,254,284
Re. 20,831	2,117,002	2,233,258	2,254,366

GUARANTEE

The Hammond Solovox is guaranteed by Hammond Instrument Company for the period of one year after date of delivery. Our liability under this guarantee is limited to replacing or repairing at our factory, or at any service station or dealer we may designate, any parts proving defective in workmanship or material during such period.

Hammond Instrument Company does not guarantee the vacuum tubes or speaker cone employed in this instrument. Such parts are standard and are covered by the guarantee of their makers.

The guarantee of Hammond Instrument Company does not extend to any damage caused to the Solovox or any of its parts because of abuse, accident, or improper operation.

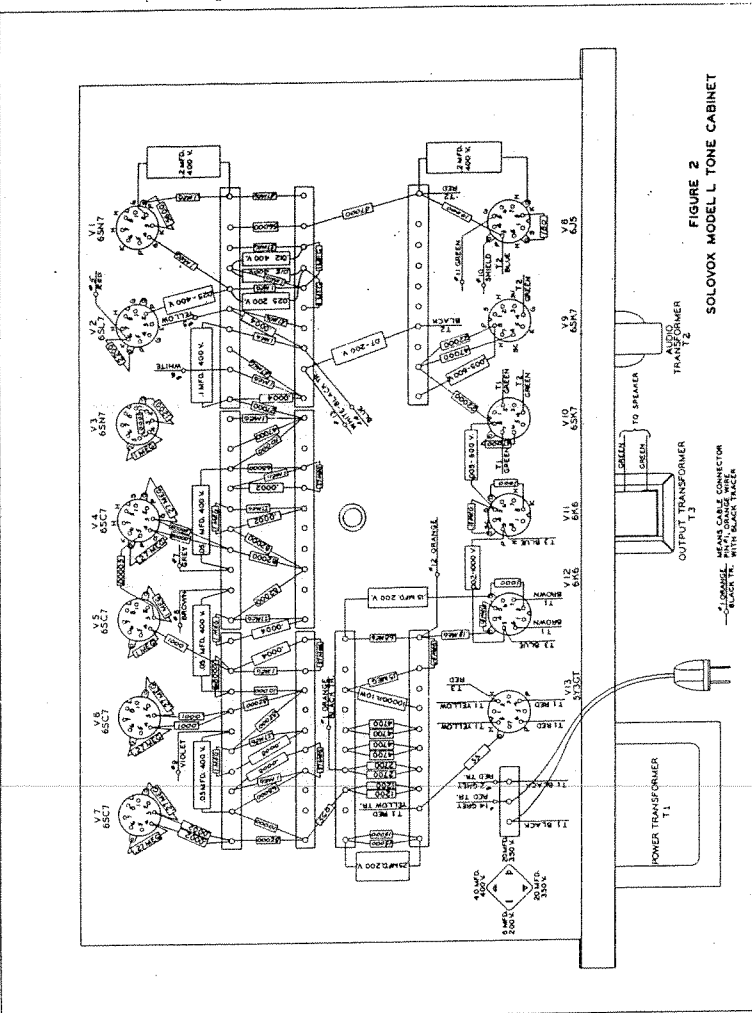
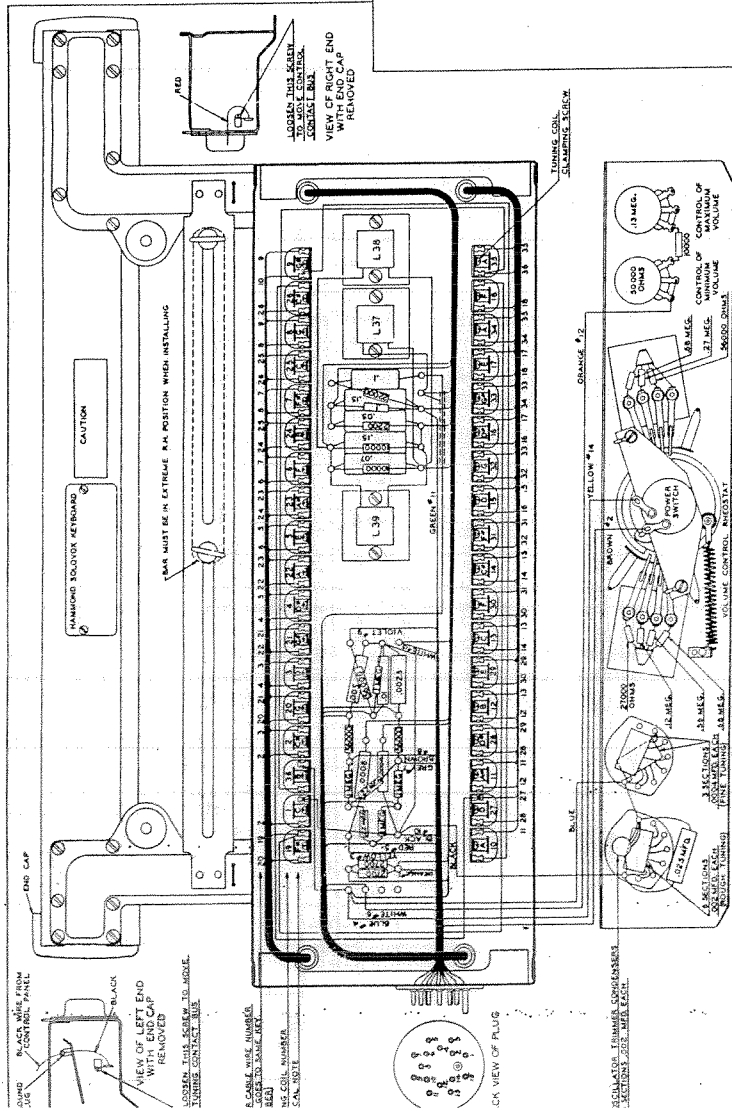

FIGURE 3
SOLOVOX KEYBOARD

SOLOVOX MODEL L INSTRUCTION SHEET

FIGURE 2
SOLOVOX MODEL L TONE CABINET

REPAIR PARTS

A great many of the electrical parts are standard radio parts, obtainable at any radio store. Such parts include tubes, resistors, and condensers, both paper and electrolytic. The correct values are given in the diagrams.

The transformers and coils are mostly special. To obtain such parts from us specify the model and serial number of your Solovox tone cabinet and the designation used in Figures 1A, 2A, or 3A. For example: Transformer T1 for Solovox Model L, serial number 92000.

We suggest that if your Solovox should ever need repair you call your nearest Hammond dealer, or ask us where nearest dealer is located. If your Hammond dealer is not conveniently available, this booklet, with the accompanying diagrams, will enable a competent radio service man to locate the trouble.

PATENTS AND TRADEMARKS

"Solovox" is the Trade Mark of the Hammond Instrument Company and is registered in the United States Patent Office.

The Solovox is protected by patents and patents pending in the United States and principal foreign countries, including the following United States Patents.

Des. 123,686	1,956,350	2,142,580	2,253,782
Des. 124,405	2,099,204	2,203,569	2,254,284
Re. 20,831	2,117,002	2,233,258	2,254,366

GUARANTEE

The Hammond Solovox is guaranteed by Hammond Instrument Company for the period of one year after date of delivery. Our liability under this guarantee is limited to replacing or repairing at our factory, or at any service station or dealer we may designate, any parts proving defective in workmanship or material during such period.

Hammond Instrument Company does not guarantee the vacuum tubes or speaker cone employed in this instrument. Such parts are standard and are covered by the guarantee of their makers.

The guarantee of Hammond Instrument Company does not extend to any damage caused to the Solovox or any of its parts because of abuse, accident, or improper operation.

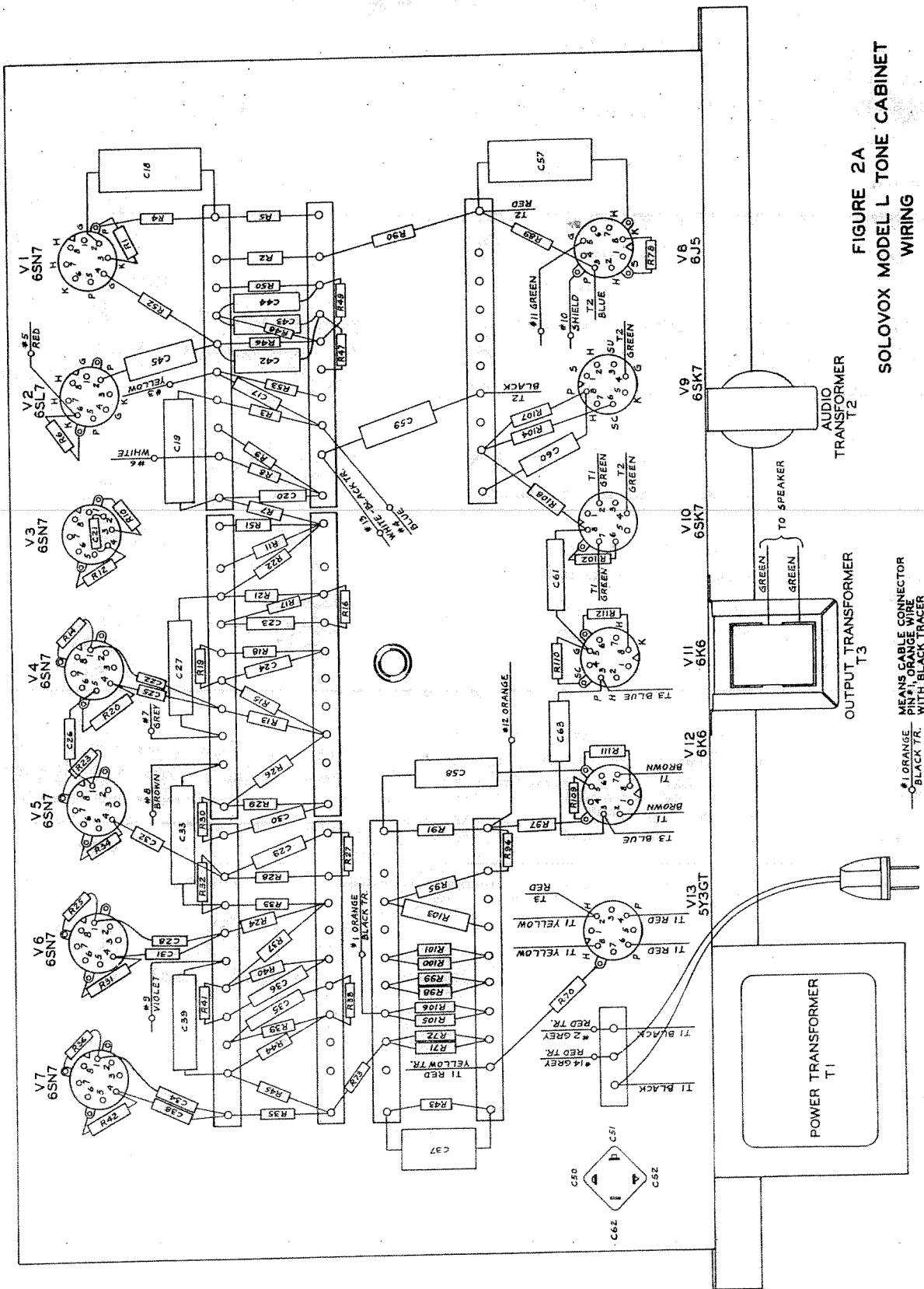

FIGURE 2A
SOLOVOX MODEL L TONE CABINET
WIRING

POWER TRANSFORMER
T1

OUTPUT TRANSFORMER
T3

AUDIO
TRANSFORMER
T2

TO SPEAKER

POWER TRANSFORMER
T1

OUTPUT TRANSFORMER
T3

AUDIO
TRANSFORMER
T2

TO SPEAKER

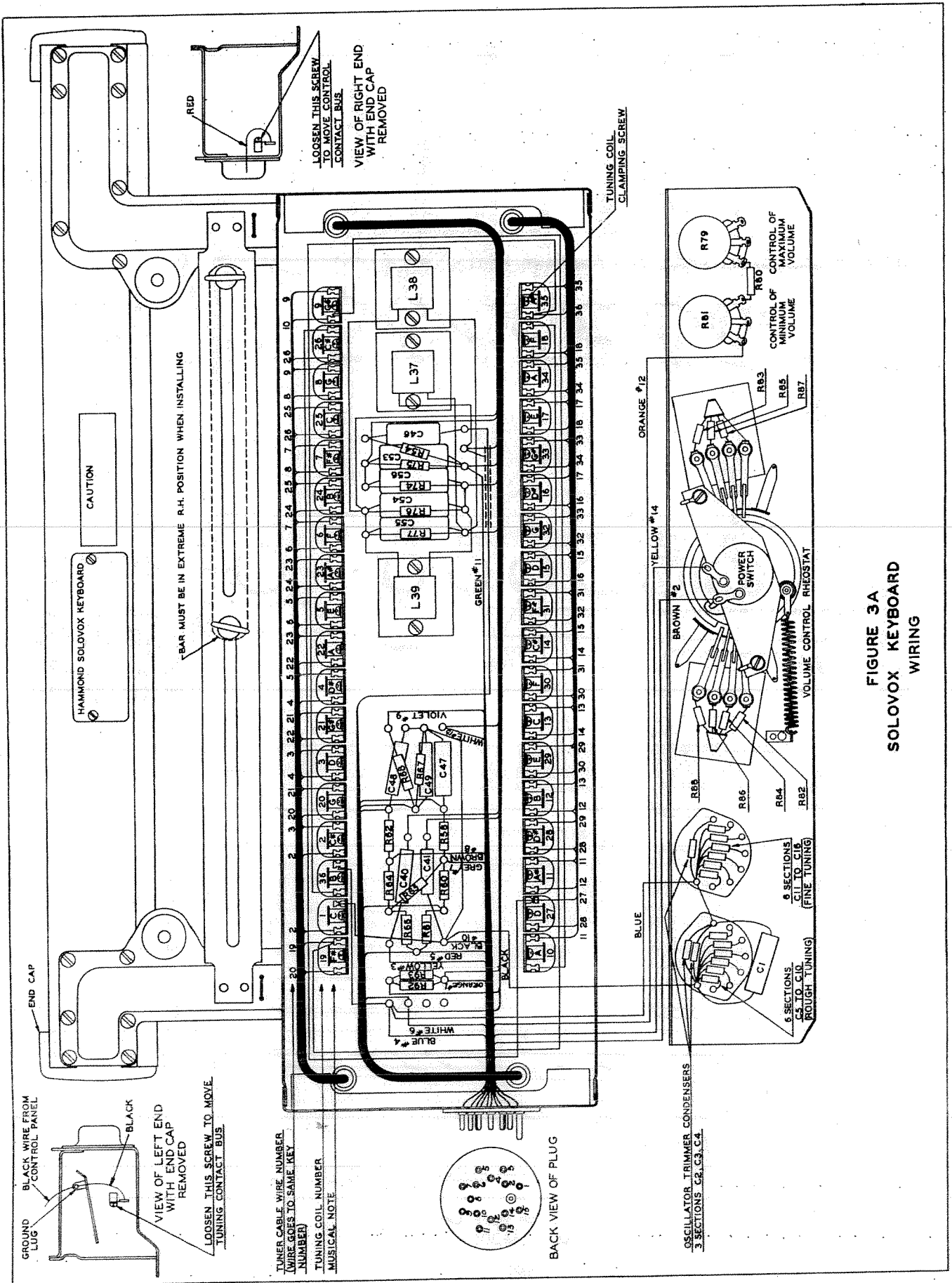
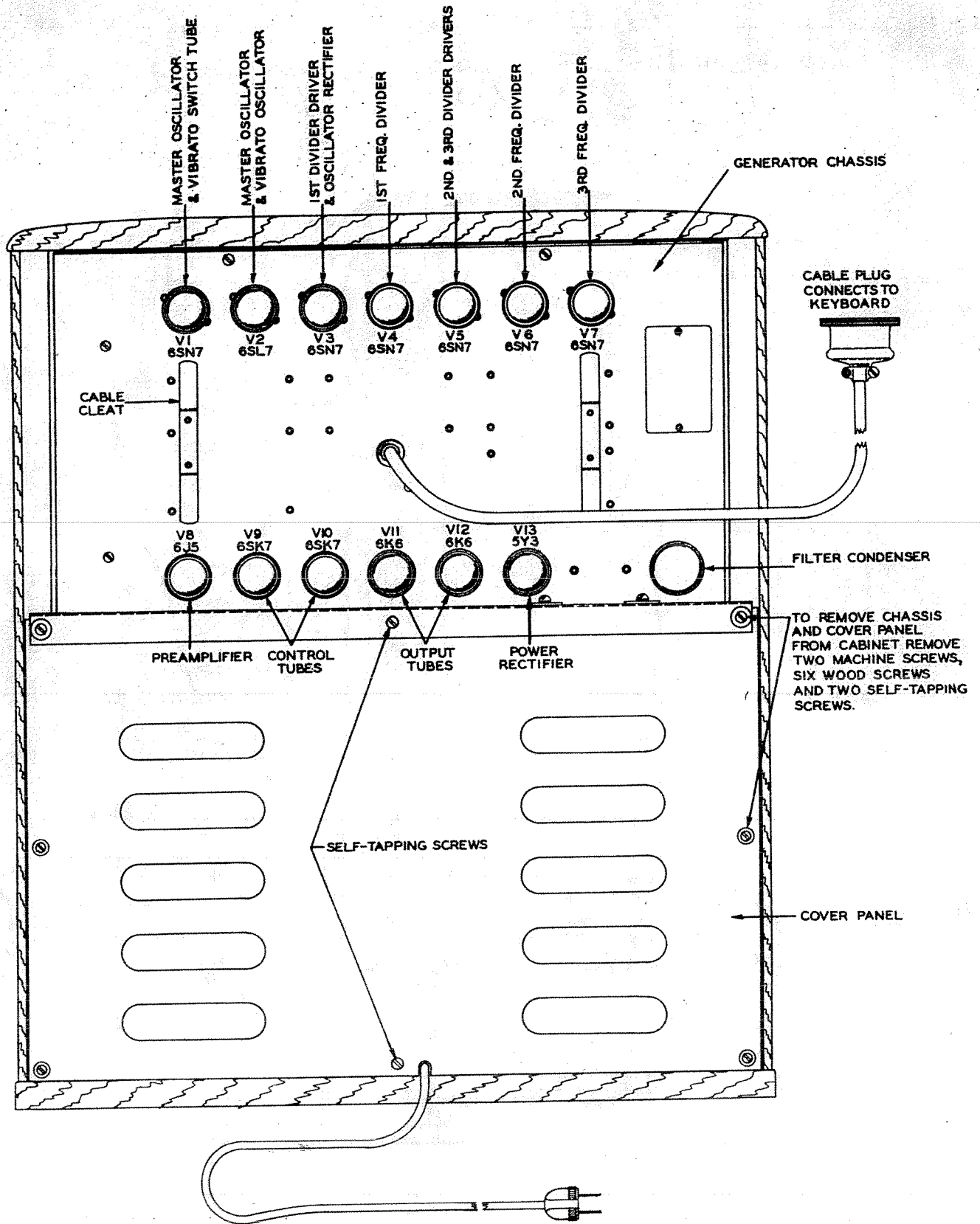
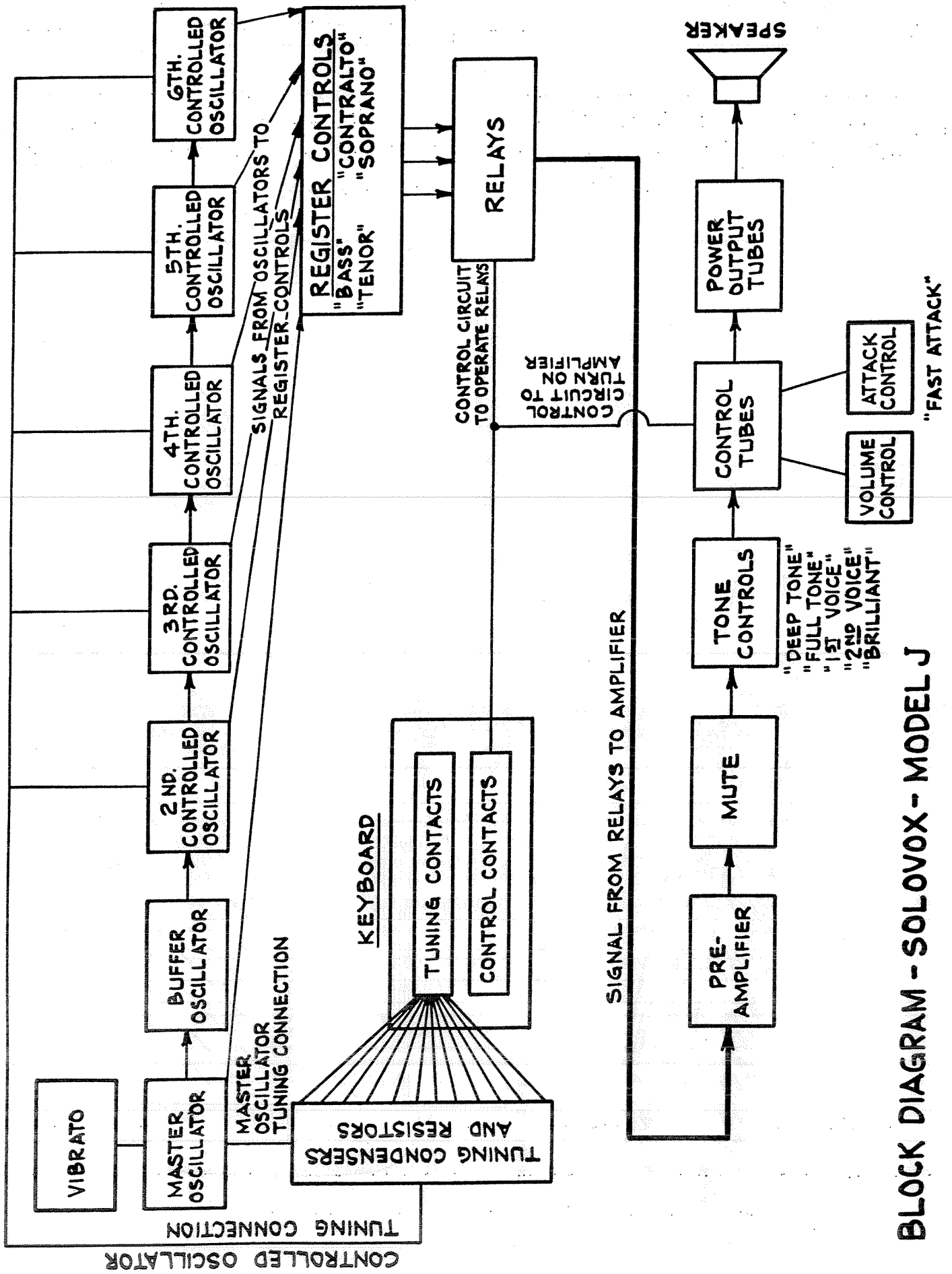

FIGURE 3A
 SOLOVOX KEYBOARD
 WIRING



REAR VIEW OF TONE CABINET
 SOLOVOX MODEL L

FIGURE 5A



BLOCK DIAGRAM - SOLOVOX - MODEL J

FIGURE 2

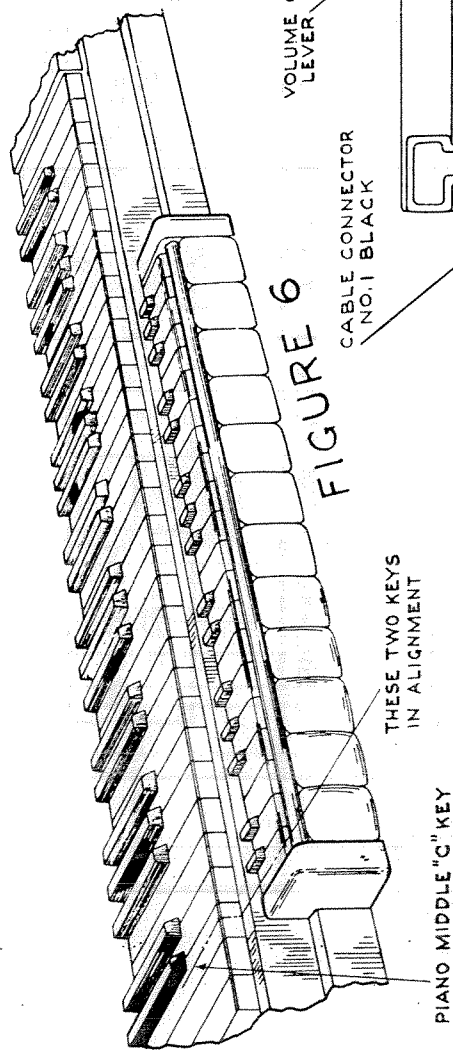

FIGURE 6

KEYBOARD IN
DUET POSITION

KEYBOARD IN
NORMAL POSITION

VOLUME CONTROL
LEVER

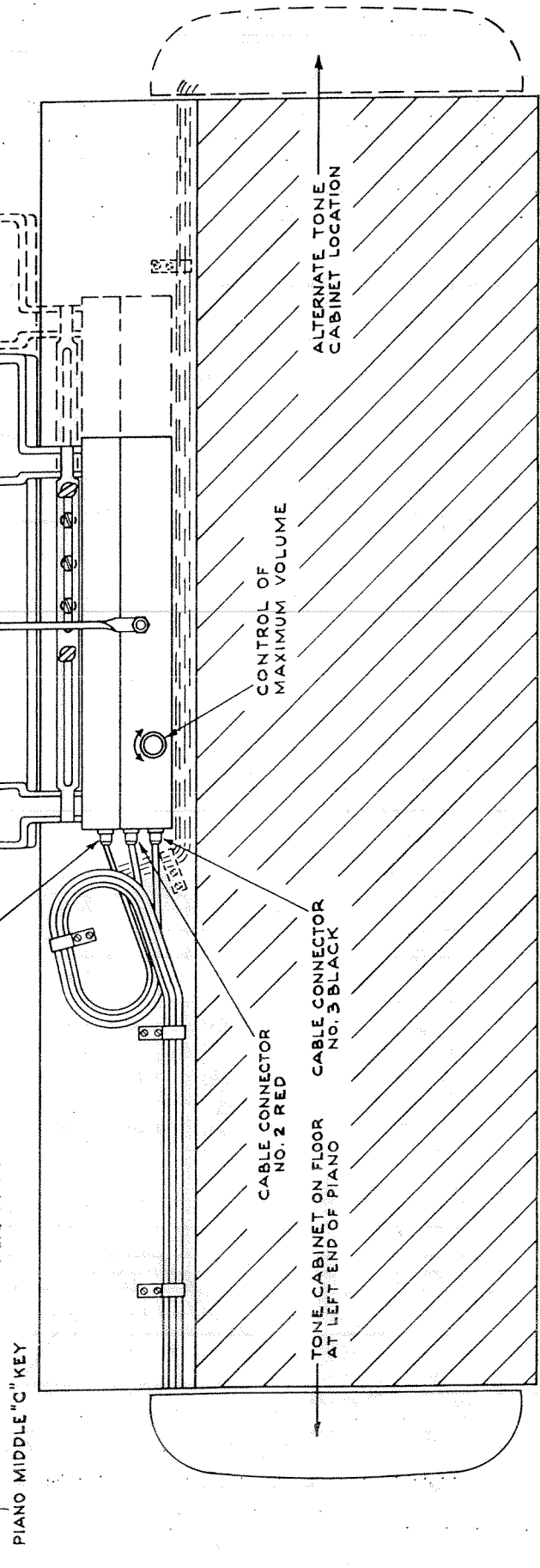
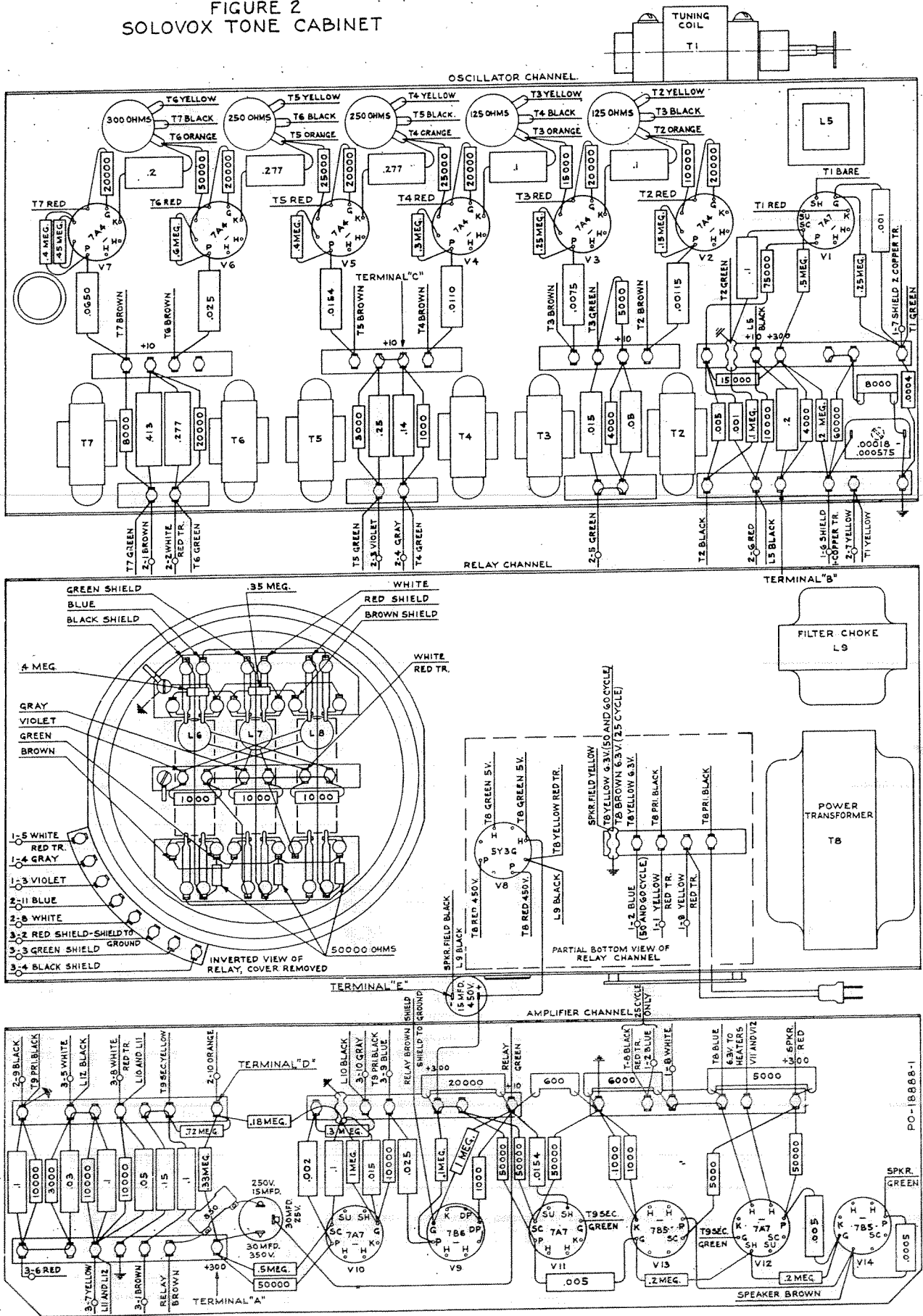
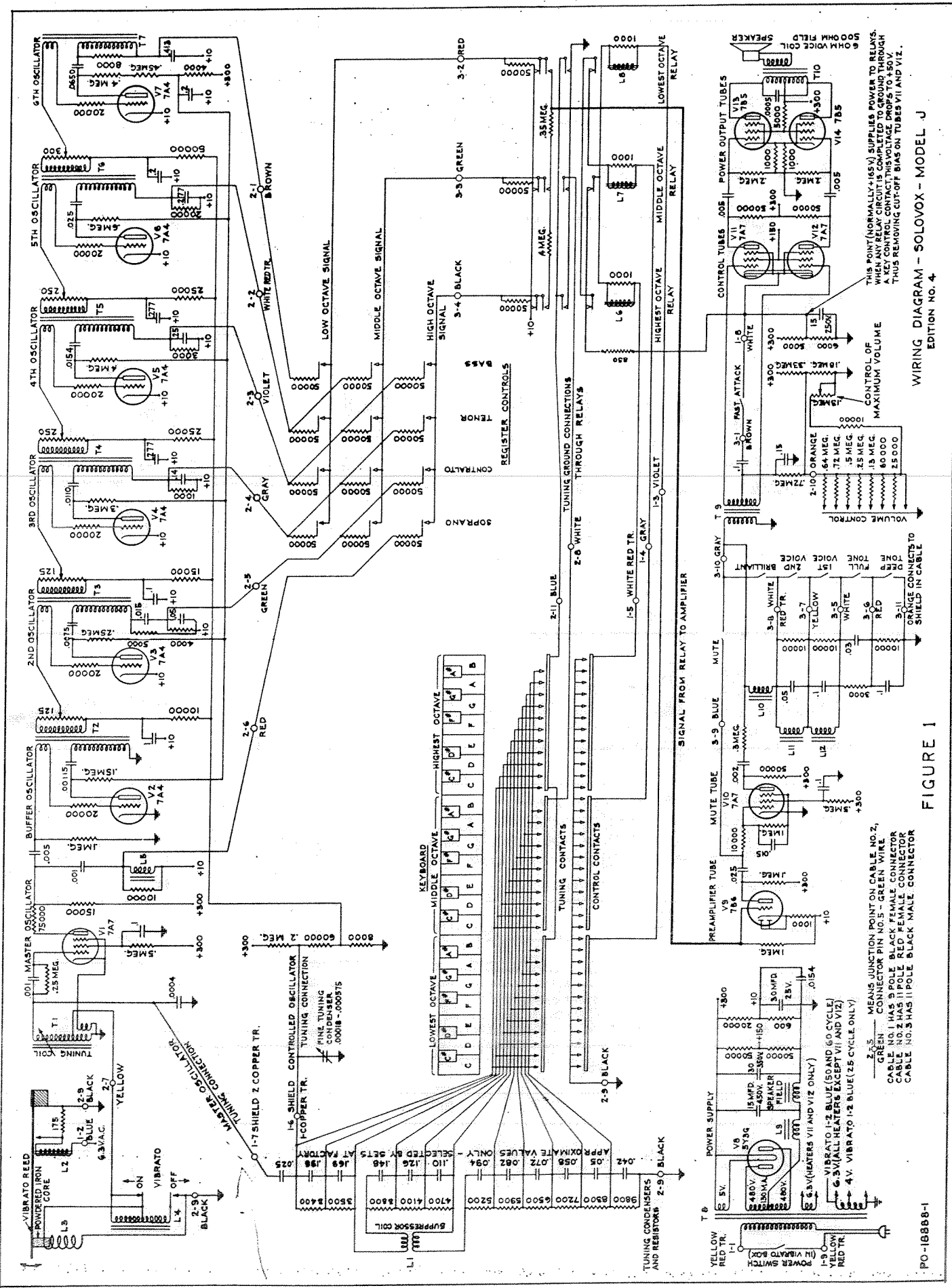

FIGURE 7

UNDER SIDE OF UPRIGHT OR SPINET PIANO SHOWING
LOCATION OF SOLOVOX KEYBOARD AND CABLES

FIGURE 2
SOLOVOX TONE CABINET





WIRING DIAGRAM - SOLOVOX - MODEL J
EDITION NO. 4

FIGURE 1

PC-16888-1

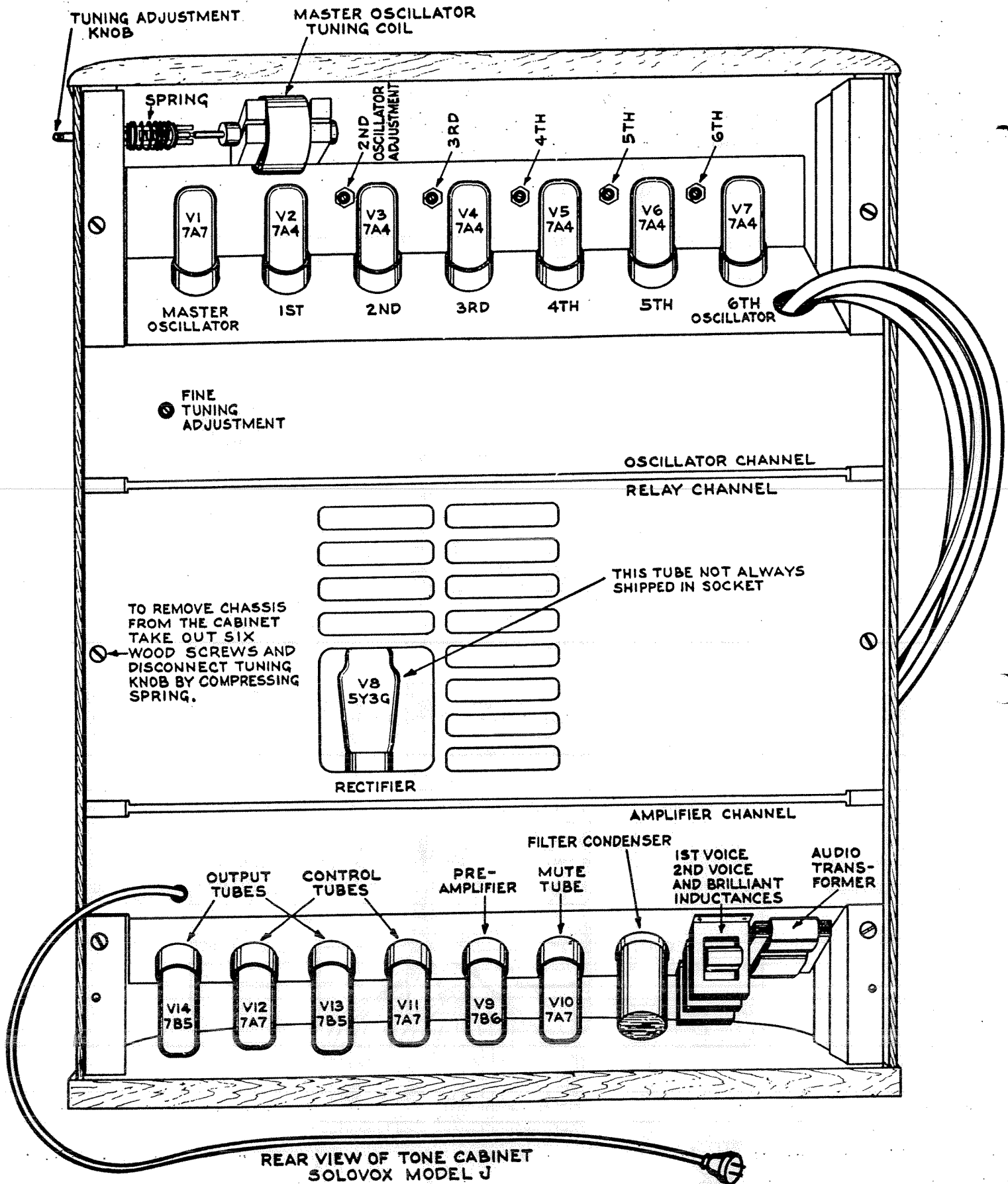
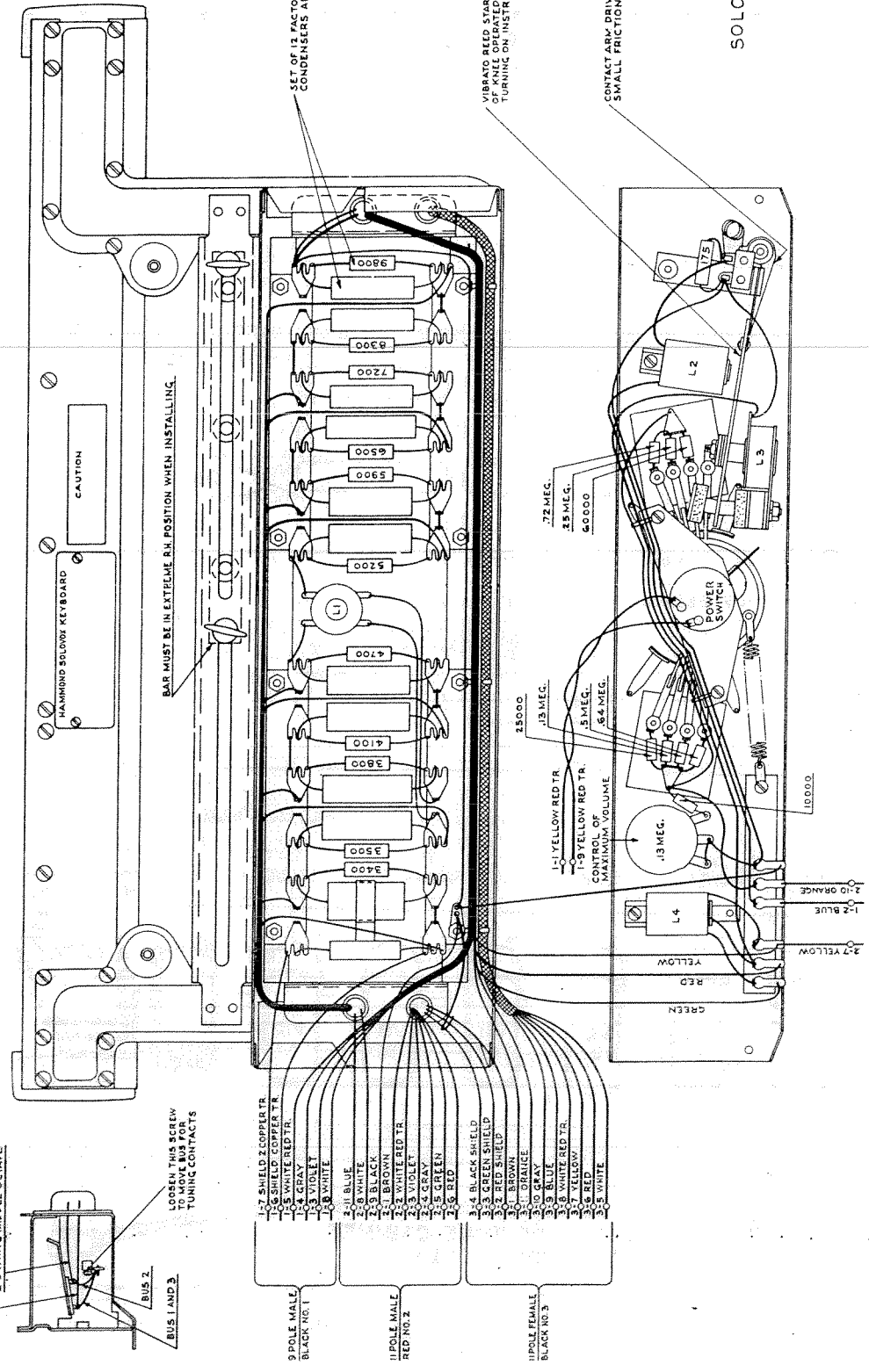
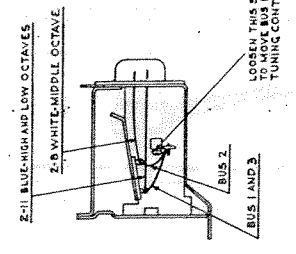
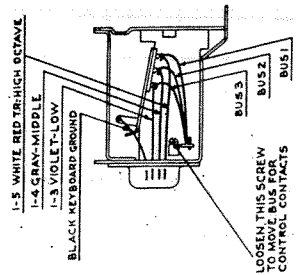

FIGURE 4



- 1-7 SHIELD Z COPPER TR.
- 1-6 SHIELD COPPER TR.
- 1-5 WHITE RED TR.
- 1-4 GRAY
- 1-3 VIOLET
- 1-2 WHITE
- 2-11 BLUE
- 2-8 WHITE
- 2-8 BLACK
- 2-7 BROWN
- 2-6 WHITE RED TR.
- 2-5 VIOLET
- 2-4 GRAY
- 2-3 GREEN
- 2-2 RED
- 3-4 BLACK SHIELD
- 3-3 GREEN SHIELD
- 3-2 RED SHIELD
- 3-1 BROWN
- 2-1 STRAINE
- 3-6 BROWN
- 3-7 WHITE RED TR.
- 3-8 RED
- 3-5 WHITE

9 POLE MALE
BLACK NO. 1

11 POLE MALE
RED NO. 2

11 POLE FEMALE
BLACK NO. 3

FIGURE 5
SOLOVOX KEYBOARD